

OPERATOR INSTRUCTION
MANUAL

HF all band Antenna Coupler

Model HC-400L

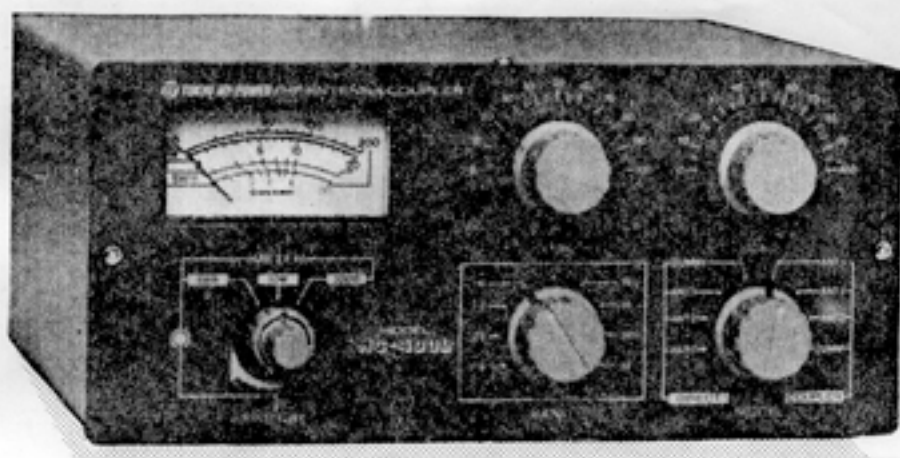

TOKYO HY-POWER LABS., INC.

Please read this instruction manual completely before starting operation in order to keep the HC-400L at its best condition for a long time.

* General Information

HC-400L is an HF all band Antenna Coupler, which contains a large accurate One Axis Two Needle Meter to indicate both power and SWR at the same time.

* Features

HC-400L is designed to cover HF all amateur bands from 1.9MHz through 28MHz including new WARC bands.

Due to the SWR detector unit with excellent frequency characteristics and a large one axis two needle meter, indication of the meter is easy to read and very accurate for the entire bands.

The dials of TUNE/LOAD variable capacitors have the vernier dial mechanisms with reduction ratio of 6 to 1, and are vibration proof. So you can operate easily and match the antenna smoothly.

On the output ends are included connectors for 3 systems of coaxial cables, a single wire terminal and an auxiliary terminal for attaching a balun for the balanced feeder. These antenna terminals can be switched by the "MODE" knob on the front panel.

Since large steatite variable capacitors are incorporated, HC-400L withstands even a high impedance load and there is still margins to the specification.

50 ohm dummy load(80W, 30 sec.) is contained internally for the speedy tuning of the transmitter.

The modified π -type circuitry with excellent bandpass characteristics is used for the coupler unit. Emission of spurious signals are well suppressed, and it is most effective for preventing TVI and BCI.

"METER" select switch and "SWR CAL" control are covered by one axis dual knobs for an easy and comfortable operation.

Please read this instruction manual completely before starting operation in order to keep the HC-400L at its best for a long time.

*Specifications

Frequency Band : 1.9, 3.5, 7, 10, 14, 18, 21, 24.5, 28MHz
(9 bands)

Input Impedance : 50 ohm (unbalanced)

Output Impedance : 10-250 ohm (unbalanced)
(14-200 ohm at 1.9MHz)

Max. handling power : 350W PEP, 150W CW (continuous)
(100W at 1.9MHz)
*for 50 ohm load

Power Meter Scale : 20W/200W (both forward Power needed
to measure and reflected
power)

SWR : 8W min.

SWR Range : 1:1 - 1:∞

Built-in Dummy Load : 50 ohm/80W (30 sec. continuous or
20W, 3 minutes)

Connectors : Input..... S0-239
Output.....a) 3 S0-239's
2 Johnson terminals
(one is auxiliary)

Dimensions : 254(W) x 114(H) x 223(D)mm

Weight : Approx. 3.4 Kg.

* Explanation of controls, etc.

Installation

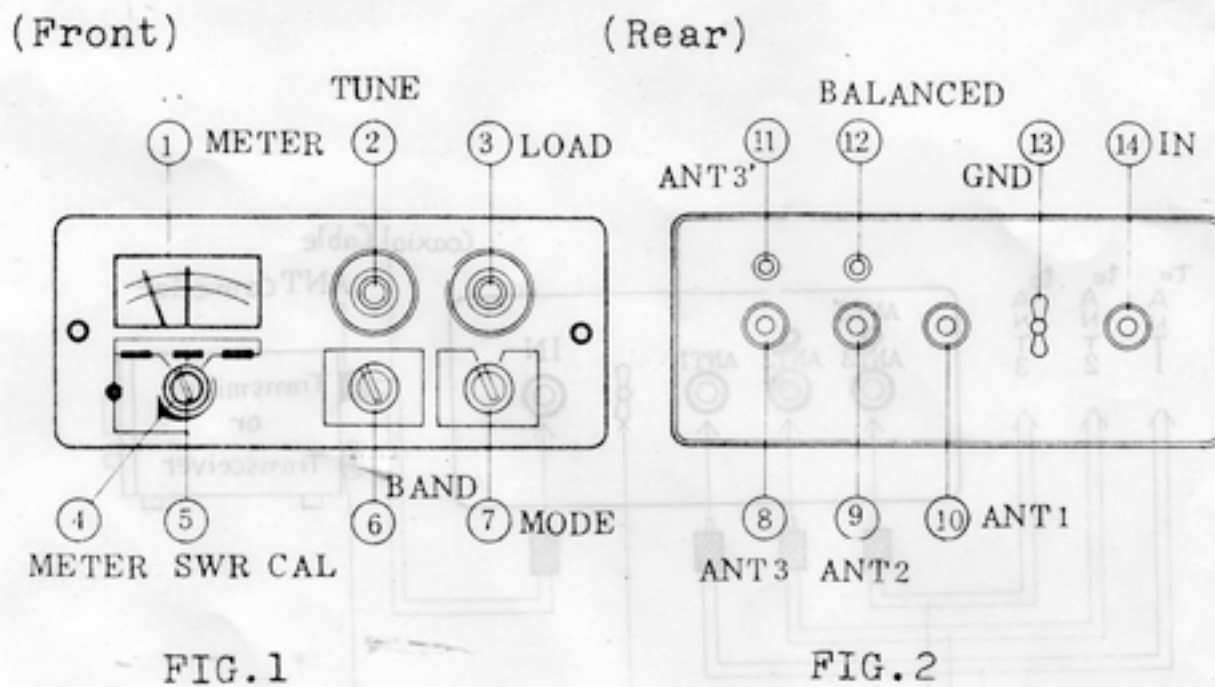

- 1. METER : Black needle indicates forward power. Red needle indicates SWR value and reflected power.
- 2. TUNE : Tuning variable capacitor. 6 to 1 vernier mechanism.
- 3. LOAD : Knob for adjusting load. 6 to 1 vernier mechanism.
- 4. METER : Knob for switching scales of SWR/20W/200W.
- 5. SWR CAL : Knob for calibrating the SWR value.
- 6. BAND : Band select switch knob.
- 7. MODE : Double knob for switching both "Antennas" and "Coupler/Direct".
- 8. ANT3 : Antenna output connector No. 3 (S0-239), connected to ANT3' output terminal for single wire inside.
- 9. ANT2 : Antenna output connector No. 2 (S0-239).
- 10. ANT1 : Antenna output connector No. 1 (S0-239).
- 11. ANT3' : Single wire antenna output terminal (Johnson type) connected to ANT3 connector in parallel inside.
- 12. BALANCED : Vacant Johnson terminal. For balanced feeding using balun, connect feeder to 11, 12 terminals. For details, refer to "About the balanced feed" at page 7.
- 13. GND : Ground terminal for connecting to GND at the transmitter, etc. or the ground.
- 14. IN(TX) : Terminal for connecting to the antenna output connector of the transmitter (or the transceiver).

*Installation

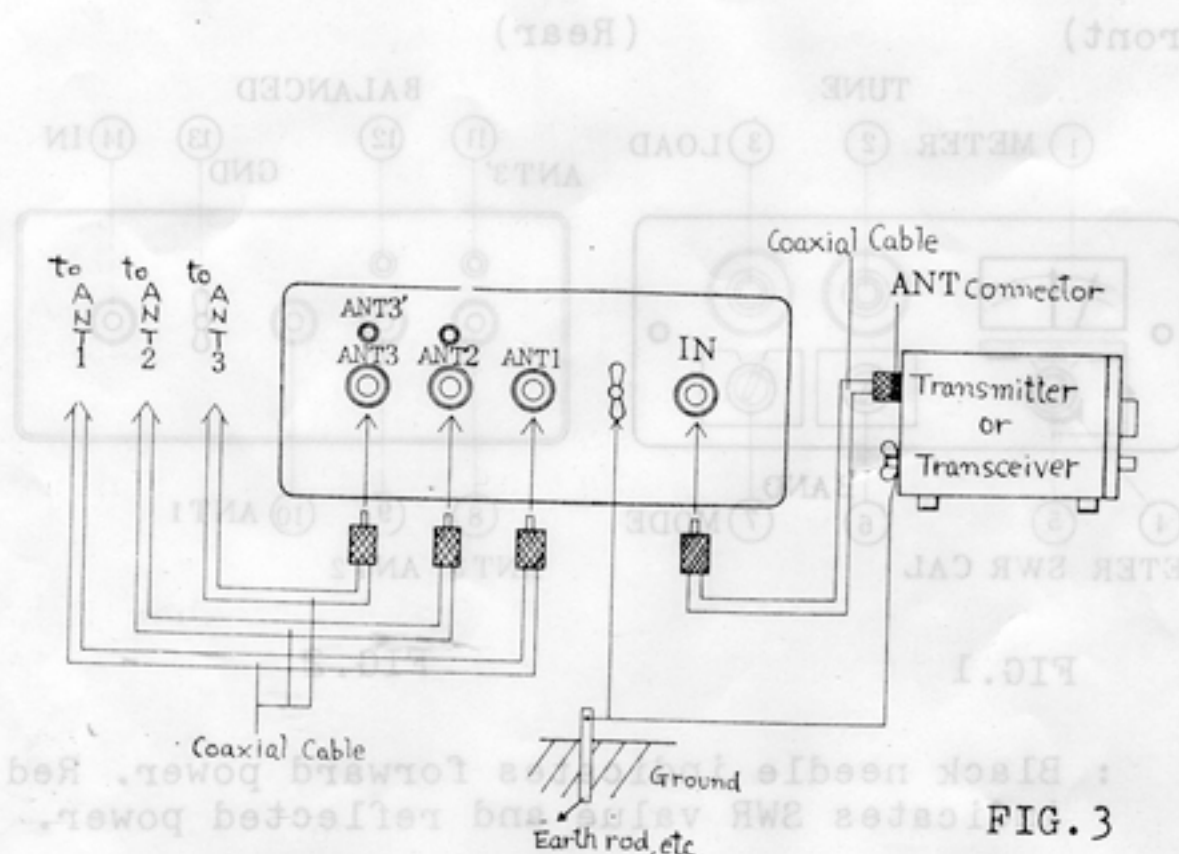

FIG. 3

1. Connect each cable according to "FIG. 3".
2. Use a 50 ohm coaxial cable(3D2V, 5D2V etc.) on the input side.
3. As ANT3(SO-239) is connected to ANT3'(Johnson terminal) connector in parallel inside, don't use them at the same time. In case of connecting single wire antenna such as long wire, etc. to ANT3' terminal, do not connect any antenna to ANT3.
4. It is not always necessary to connect GND to the ground, but we recommend that the grounding construction is finished in order that the shielding effect of *HC-400L works better.
5. In case that the grounding is done by burying an earth rod, etc. into the ground, connect one side of wire as short and thick as possible to GND terminal at the rear panel and the other side of wire into the ground. One end of grounding wire from the transceiver should be connected to the grounding wire for HC-400L in the ground.

*Preparation before operation

1. Set the "BAND" knob to the operating frequency position.
2. Set the "METER" knob to the 20W or 200W position.
20W for the 10W transceiver. 200W for the 100W transceiver.
3. Set the "MODE" knob to the "DIRECT/DUMMY" position.
4. Transmit a carrier of low level power from transceiver and tune the transceiver(or transmitter) so that the needle of the "POWER" meter (black needle) comes maximum.
For preventing the built-in dummy load from being burned, tune them quickly with low power(under 20W within 5 minutes, or 80W within 30 seconds).
5. When you finish this tuning, the transceiver should have been tuned at the best condition.

*The method of measuring the power level directly

1. Set the "METER" knob to the "20W" or "200W" position in accordance with the rated output power of the transceiver. Set to "20W" for the 10W transceiver, "200W" for the 100W transceiver.
2. Set the "MODE" switch to the desired ANT position among ANT1 to ANT3 of "DIRECT" range.
3. Transmit a carrier and read the meter. Black and red needles indicate the forward and reflected powers respectively and simultaneously.
4. When the "METER" knob is set to the "200W" position, read the upper part of double scale(200W full scale) and when to the "20W" position, read the lower scale(20W full scale). At high SWR, red needle also swings. Read the same scale for both the forward and reflected powers.
5. Be careful that the meter doesn't indicate accurate values if SWR is high and spurious signals are contained in a carrier.

Red needle(reflected power/SWR)

Black needle(forward power)

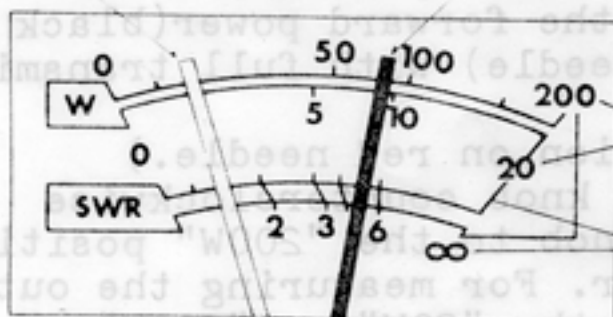

POWER(forward wave, reflected wave)
"Read the indication of red and black needles"
SWR (Read the deflection of red needle)

FIG.4

*The method of measuring the antenna SWR directly

1. Set the "METER" knob to the "SWR" position and turn the "SWR CAL" knob fully counterclockwise.
2. Set the "MODE" switch to the desired ANT position of ANT1 through ANT3 in "DIRECT" range.
3. Transmit a suitable level of carrier (8W-20W).
4. Turn the "SWR CAL" knob slowly clockwise and adjust the needle (black) of the "POWER" meter to the full scale(200/20W). Then, the indication of the needle(red) on the "SWR" meter is the SWR value.
5. Read the upper scale when the carrier power is under 20W and the lower scale when over 200W for the scale of the SWR(red scale).
6. If you try to adjust with full power from beginning, it may happen that the transmitter is damaged or that the meter is damaged due to excessive deflection. So, turn it clockwise gradually as the needle starts swinging and keep the carrier power relatively low.

*Operation of coupler

1. Set the "MODE" switch to the operating ANT position of ANT1 through ANT3 in "COUPLER" range.
2. As the tuning is started with low power, the meter select should be at either "SWR" or "20W" position. However, when you set the "METER" knob to the "SWR" position, set the "SWR" knob to the suitable position so that the needle doesn't swing over.
3. Turn on the transmitter and transmit a carrier (approx.5-10W).
4. Watching the needle deflections of the meter, tune the "TUNE" and "LOAD" alternately. And try to maximize the forward power (black needle) and minimize the reflected power(red needle). (Refer to the next table for dial setting.)
5. Increase the carrier power gradually, and repeat the above procedure. Finally adjust to maximize the forward power(black needle) and minimize the reflected power(red needle) with full transmitting power.
(It is ideal that there is no deflection on red needle.)
When adjusting, turning the "SWR CAL" knob counterclockwise repeatedly or switching the "METER" knob to the "200W" position so that the needle does not swing over. For measuring the output power, if you set the "METER" knob to the "20W" or "200W" position, the black needle indicates the power directly.

6. For measuring SWR after coupler adjustment, leave the positions of the "MODE", "TUNE" and "LOAD" knobs as they are, and refer to "The method of measuring the antenna SWR directly" at page 6. In this case, measuring can be done with the full transmitting power.
7. When you use the linear amplifier, be careful not to damage the coupler components, switches etc. with the higher power than the rating.

Dial positions of the tuning controls of the variable capacitors 50 ohms loading

Knob \ MHz	1.9	3.5	7	10	14	18	21	24.5	28
TUNE	20	50	55	75	70	65	75	60	60
LOAD	60	70	70	70	7.5	80	85	80	75

(Above are approximations for starting references)

*About the balanced feed

For balance feeding by using the ladder-type feeder and TV feeder, prepare the balun according to FIG.5 and set it in the coupler. The figure shows a balun with the impedance ratio of 1 : 4.

FIG.5(How to construct a balun)

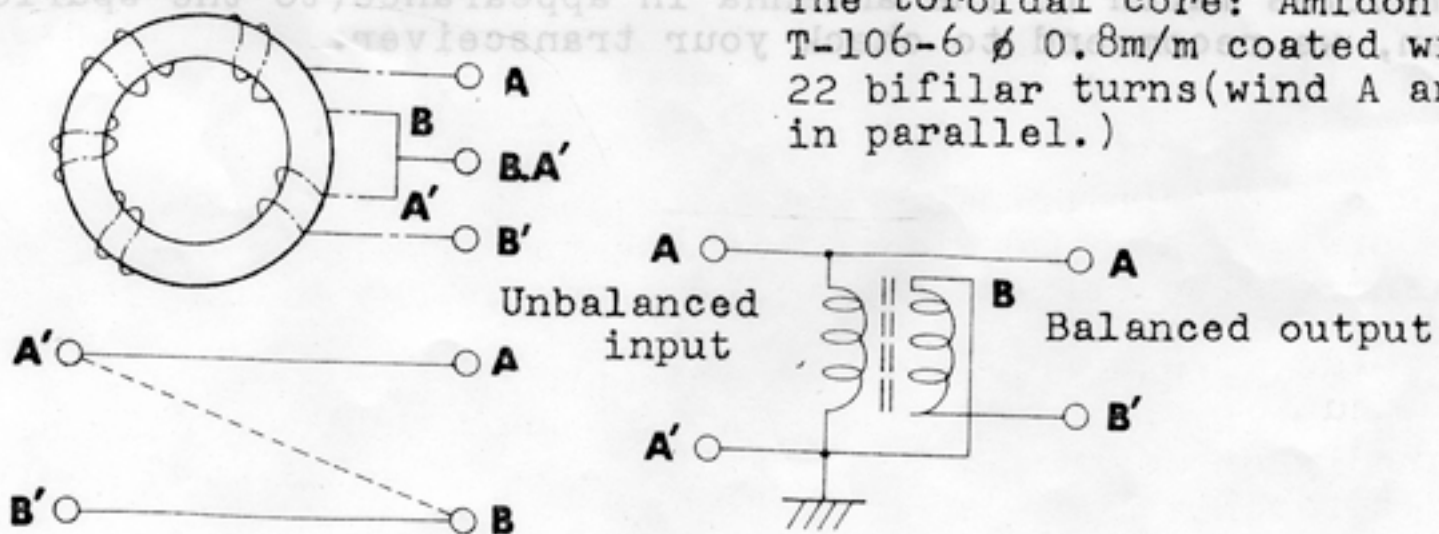

The toroidal core: Amidon Co. T-106-6 ϕ 0.8m/m coated wire 22 bifilar turns(wind A and B in parallel.)

FIG.6(How to connect the balun, viewed inside of the set)

BALANCED(connect feeder)

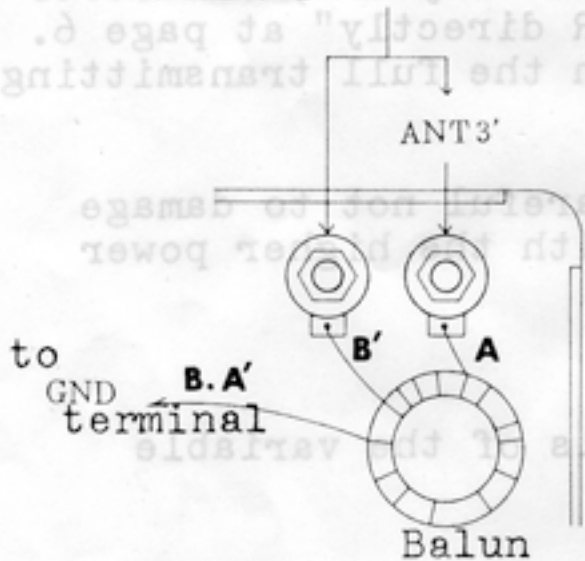

*Solder each edge of the winding leads according to the figure without changing any other inside wiring.

*Now ANT3' terminal can not be used independently.

		KHz		MHz	
		TUNE		LOAD	
1.0	2.5	10	20	1.0	2.5
1.5	3.5	15	30	1.5	3.5
2.0	4.5	20	40	2.0	4.5
2.5	5.5	25	50	2.5	5.5
3.0	6.5	30	60	3.0	6.5
3.5	7.5	35	70	3.5	7.5
4.0	8.5	40	80	4.0	8.5
4.5	9.5	45	90	4.5	9.5
5.0	10.5	50	100	5.0	10.5
5.5	11.5	55	110	5.5	11.5
6.0	12.5	60	120	6.0	12.5
6.5	13.5	65	130	6.5	13.5
7.0	14.5	70	140	7.0	14.5
7.5	15.5	75	150	7.5	15.5
8.0	16.5	80	160	8.0	16.5
8.5	17.5	85	170	8.5	17.5
9.0	18.5	90	180	9.0	18.5
9.5	19.5	95	190	9.5	19.5
10.0	20.5	100	200	10.0	20.5

*Cautions

1. If you transmit with full power under the condition that the SWR value is not kept low or that you have not tuned the coupler yet, this device and the final stage of the transceiver can be damaged. So, start with low power initially at adjustment, then increase it gradually as the matching is made.
2. If you turn the "BAND" or "MODE" switch carelessly while transmitting, switches and other parts can be damaged due to the high RF voltage.
3. When you can not match to the antenna by any means after adjusting the coupler (the reflected power can not be reduced fully), the impedance of the antenna seems to be out of the nominal rating of this coupler. If you switch the "BAND" knob to upper or lower position of the operating bands, matching can be sometimes made more easily. If the strong high or low harmonics are contained, you can not sometimes match to the antenna in appearance(to the spurious). Then, we recommend to check your transceiver.

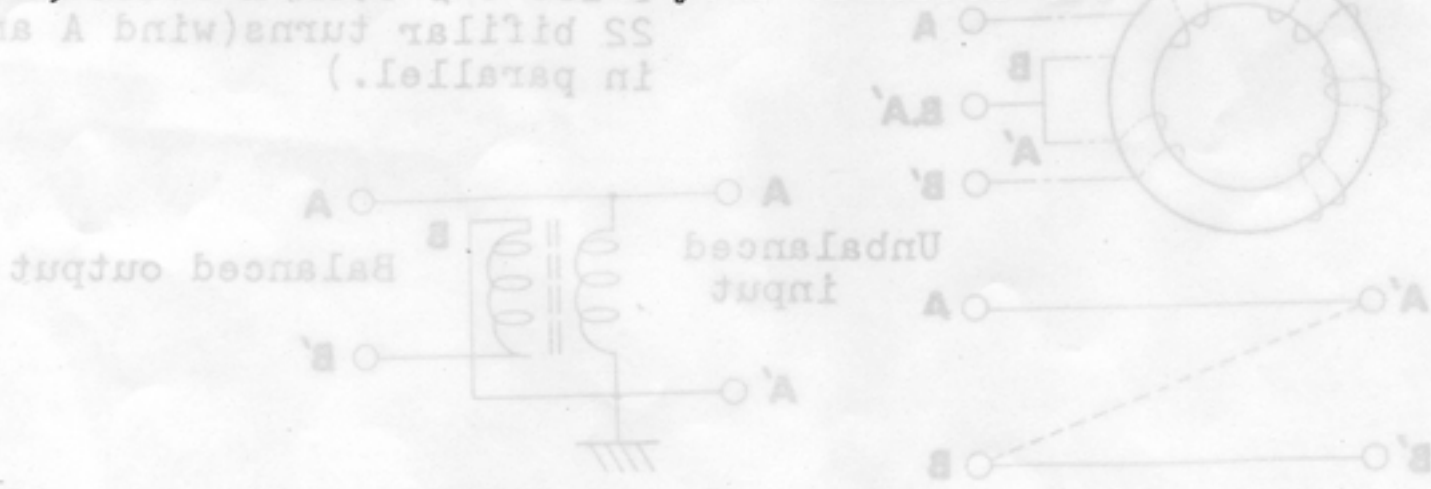

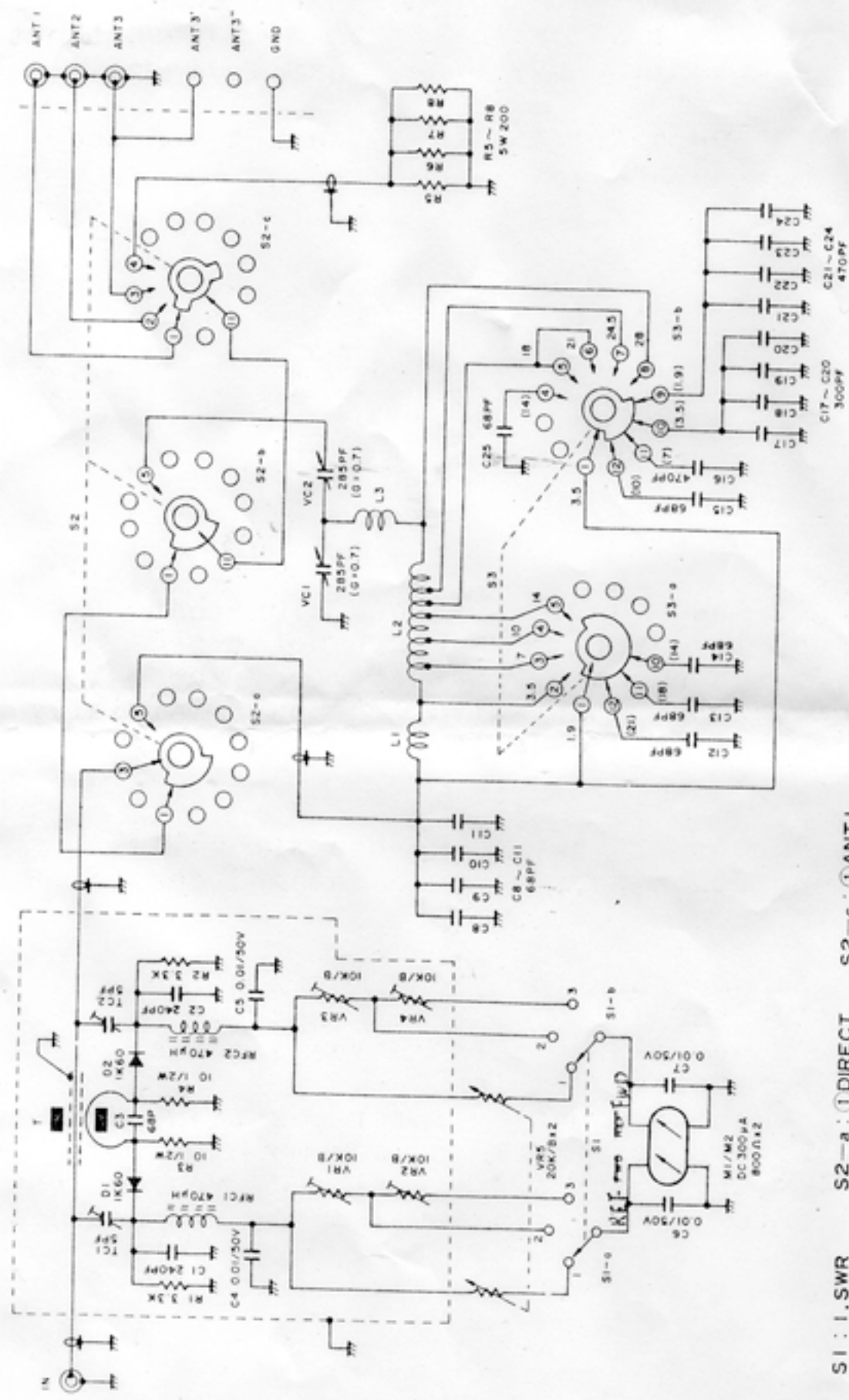

- S1 : 1. SWR
2. 20W
3. 200W
- S2-a : ① DIRECT
② COM
③ COUPLER
- S2-b : ① DIRECT
② COUPLER
③ COM
- S2-c : ① ANT1
② ANT2
③ ANT3/3WIRE
④ DUMMY
⑤ COM

*C4, 5, 6, 7 : 50V Ceramic capacitor
 *All capacitors without notes: 500V FM capacitor

CIRCUIT DIAGRAM HC-400L
 TOKYO HY-POWER

The diagram is subject to change without notice.

TOKYO HY-POWER LABS., INC.
1-1 Hatanaka 3-chome
Niiza, Saitama
352
Japan
Phone: (0484) 81-1211